

## Welcome to the PROMS IN THE PLAYGROUND resources pack



#PromsInThe  
Playground

You will know by now that **PROMS IN THE PLAYGROUND** is a national, musical initiative from Brass Bands England's Brass Foundations Programme that seeks to link Brass Bands with their local school to provide a free, fun performance in their playground during the last three weeks of the summer term.

You will have arrived at this page because you have already been invited or you are already involved in planning a **PROMS IN THE PLAYGROUND** event with your local Brass Band. Great!

To actively support the musical learning that your school is going to experience, the **BRASS BANDS ENGLAND BRASS FOUNDATIONS** team have created these resources to enhance and develop your pupils' understanding of what is an integral part of our country's musical landscape. - Brass Bands.

The resources are targeted towards EYFS, Key Stage 1 and Key Stage 2 and can be used either to prepare the children for your upcoming event or to reflect upon it, so pre- or post-event. The pack includes activities which can be used as standalone activities or can be integrated into a longer unit of work and are focused on the three basic strands of the music curriculum. There are some physical, practical activities, performance-based tasks, pieces of work to focus on listening and opportunities to compose music of their own. All our activities reflect the intentions of the Model Music Curriculum, developing skills and knowledge whilst focusing on our unique, inclusive and community-centred music-making.

We hope you enjoy the whole experience of having a Brass Band playing for you in your playground. We would LOVE to see the work that your children do and hope that you will be able to share it with us by sending examples and messages about how you have used our resources.

Have Fun!

The Brass Bands England Brass Foundations Team.

# Sample initial contact email...



Dear \_\_\_\_\_

Allow us to introduce ourselves. We are the \_\_\_\_\_ band, a traditional British brass band, and we have been based in your area / town / village for the last \_\_\_\_ years.

Brass Bands England (BBE) is encouraging community bands to connect with their local schools by offering a live performance in their playground, so here we are! We would like to come and perform in your playground as part of the national **Proms in the Playground** initiative that links schools with local, community organisations. We think that this is a great opportunity for your school to welcome live musicians to perform for the children and to experience a part of their local cultural heritage. We would love to share what we do with your school community in the form of a short, **FREE**, concert / demo / taster session. A collaborative event which provides a platform for your own young musicians to perform alongside us would be ideal. We would also like the children and their parents to know about the musical opportunities that we can offer both as a child and as they grow into adults - we specialise in life-long learning!

The National Plan for Music Education 2 says "**Primary music leads should think about opportunities to invite performances from local secondary pupils or local ensembles (Hub ensembles or broader community groups), to help build links and provide role models for younger pupils.**"

We'd also like to offer you some curricular support in the form of some free resources that you can use to enhance the whole experience. The NPME2 tells us that "**Teachers will want to consider how such opportunities can be linked into their curriculum delivery, so that they build on the pupils' learning, and how they can reflect and build on pupils' own musical interests and passions.**" They have been created with KS1 and KS2 in mind, with performing, listening and composing activities included, along with some physical makes and ideas. Samples can be found here \_\_\_\_\_

The Proms in the Playground weeks for 2023 are from 3rd - 23rd July. I would love to meet with you to find out how we can work together and I hope that we can organise a performance during this summer term window.

Yours sincerely,

## FIND OUT MORE... Music Stand Banners

Your school has a special day in July when it is going to be visited by a Brass Band. We think you'll love it! Brass Bands play lots of different types of music with brass and percussion instruments.

When Brass Bands play in concerts, the players wear uniforms and decorate their music stands with a 'music stand banner'.

Here are some examples of banners that belong to Brass Bands.



You are going to design your own music stand banner.

You could:

- Use your school colours and logo
- Have the name of your school band or the band that is visiting you on it.
- Make up your own logo

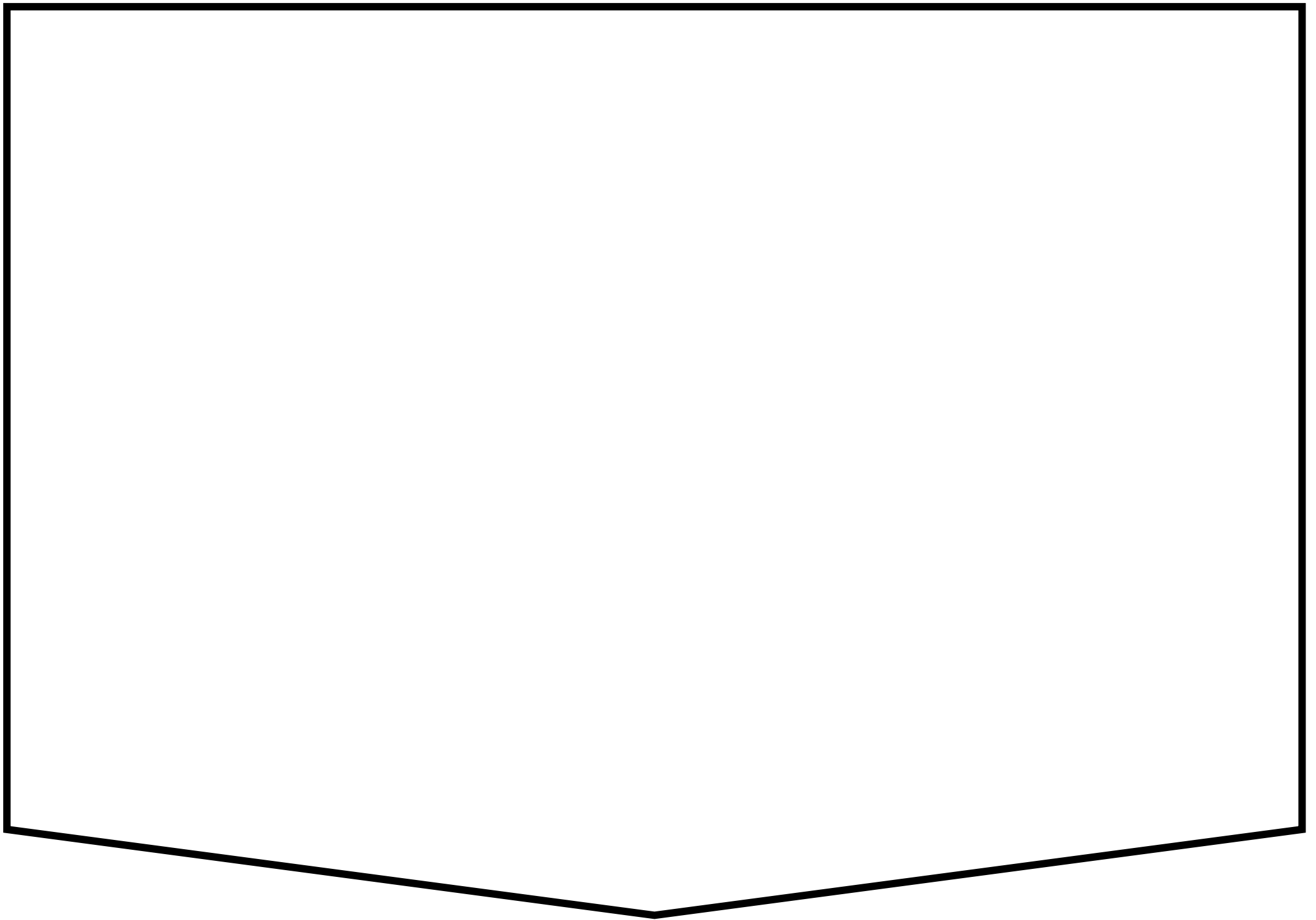

FIND OUT MORE... Proms in the Playground Bunting



#PromsInThe  
Playground

Your school has a special day in July when it is going to be visited by a Brass Band. We think you'll love it!

Brass Bands play lots of different types of music with brass and percussion instruments.

We decorate things with bunting when we celebrate something special. It's your turn to make some bunting about music and Brass Bands for when the Brass Band comes to your school.

We have some pictures you can colour or blank bunting you can design yourself. Have fun!



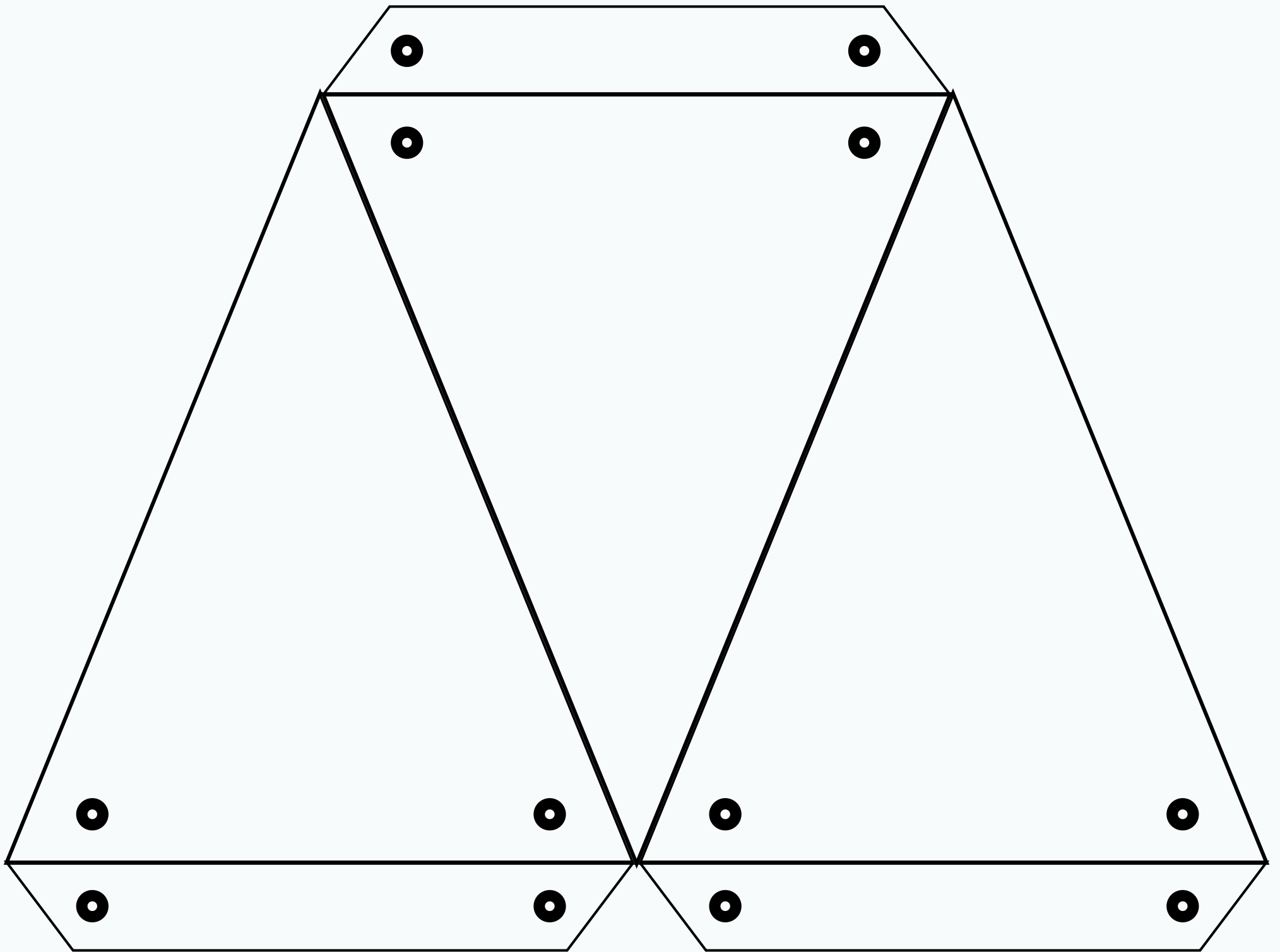

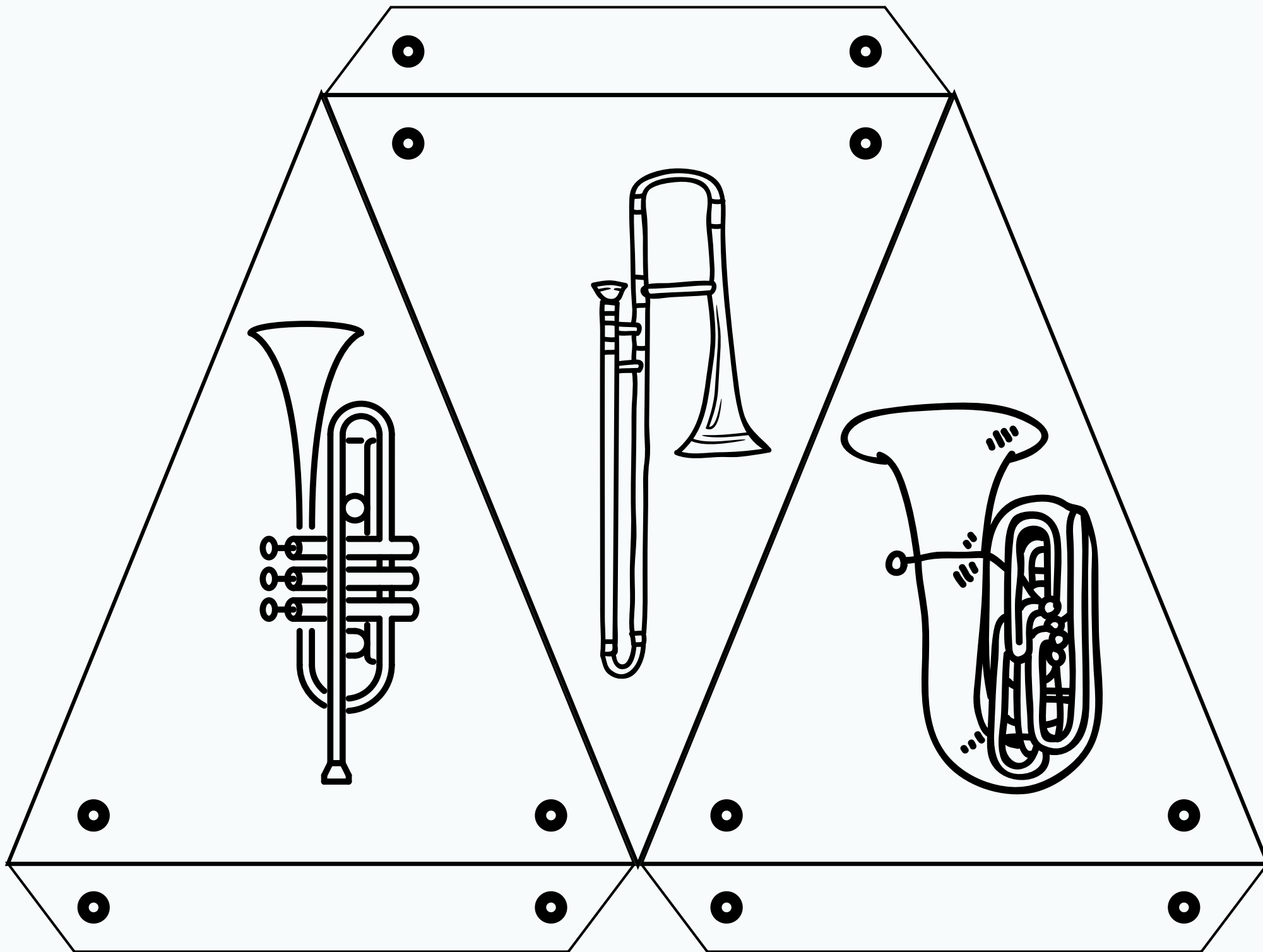

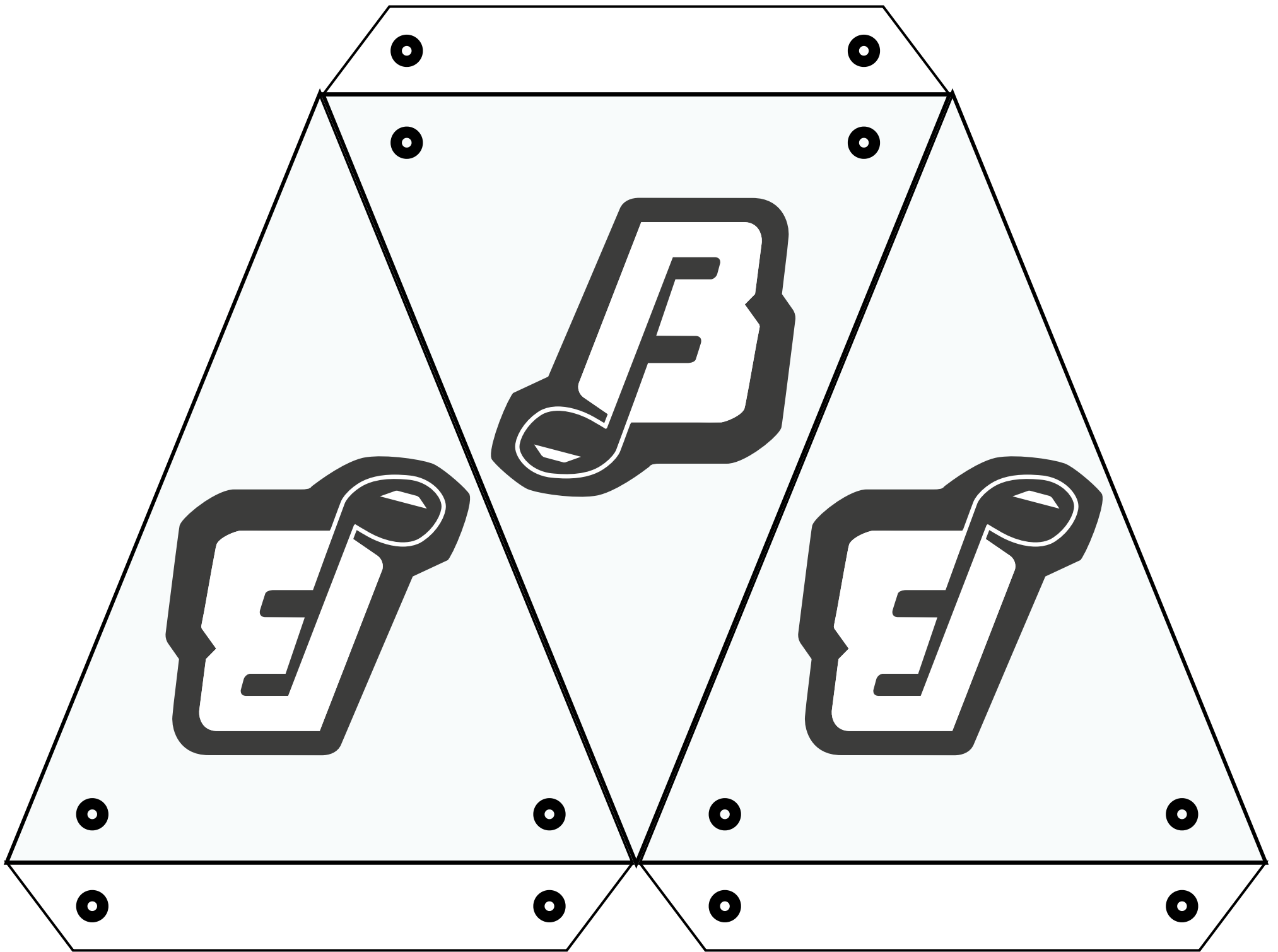



## FIND OUT MORE... composing a fanfare

Your school has a special day in July when it is going to be visited by a Brass Band. We think you'll love it! One thing that brass instruments are great at doing is playing fanfares and today, it's your turn to compose and play your own.

Let's watch some fanfares being played!

Fanfare for a Dignified Occasion | Composed by Arthur Bliss | Performed by the London Fanfare Trumpets

Bugler's Dream Olympic Fanfare | Composed by John Williams | Performed by the Bands of HM Royal Marines

Fanfare from the Overture to William Tell | Composed by Giachino Rossini | Performed by the Cory Band

### What is a fanfare?

A fanfare is usually played on brass instruments.

A fanfare announces the arrival of someone important or tells you that something is going to start.

### Composing your own fanfare

Use glockenspiels or xylophones to compose your own fanfare using the steps below. You might like to play it to announce the start of your Proms in the Playground event.

You could do this by yourself, with a partner or in a group.

# FIND OUT MORE... composing a fanfare

## First

Choose three or four notes to use in your fanfare.



## Next

Play the notes you have chosen and work out how your fanfare will sound.

You can use each note more than once.



## Then

Practice it until it is ready to share with the rest of your class.

Make sure it sounds like someone important is arriving!



## Finally

Perform your fanfare and listen to others in your class play theirs

## Try it out!

Choose someone in your class to act like a famous person. Perhaps a king or queen, or pop star. Get them to walk into your classroom while you are playing your fanfare. Does it sound like someone important is arriving?

## Play it again...

Practice it and play it at your Proms in the Playground concert. When else could you play it?

## FIND OUT MORE... dynamics

Your school has a special day in July when it is going to be visited by a Brass Band. We think you'll love it!

Brass Bands play lots of different types of music with brass and percussion instruments. They love to use lots of different dynamics. Do you know what dynamics are?

When we write or talk about music, we use Italian words to describe the dynamics. Here are some you might like to use in the following activities.



Forte

Loud



Mezzo Forte

Moderately loud



Mezzo Piano

Moderately soft

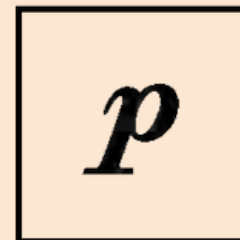

Piano

Quiet

# FIND OUT MORE... dynamics

Listen to the William Tell Overture. | Composed by Rossini | Performed by Grimethorpe Colliery Band.

Choose some of the following activities to do while you listen.

## Responding to music:

When the music is loud (forte) stretch up and make yourself really big!

When the music is quiet (piano) make yourself really small.



# FIND OUT MORE... dynamics

Listen to the William Tell Overture. | Composed by Rossini | Performed by Grimethorpe Colliery Band.

## Moving to music:

When the music is loud (forte), use your feet to stomp around the room.  
When the music is quiet (piano), tiptoe.

Can you stay in time with the music?

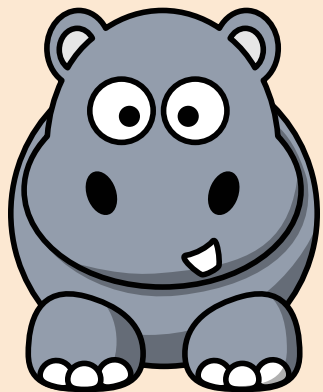

Which animal do you think would be good at being forte?  
Which animal do you think would be good at being piano?

Move around like those animals in time with the music.

# FIND OUT MORE... dynamics

Listen to the William Tell Overture. | Composed by Rossini | Performed by Grimethorpe Colliery Band.

Playing with dynamics:

Choose a percussion instrument. Find two different ways of making sound on it. One that is forte, one that is piano.

Play along with the William Tell Overture making sure you are loud and quiet at the right times.

Why not challenge yourself and try to play mezzo forte (moderately loud) or mezzo piano (moderately quiet)?



# FIND OUT MORE... dynamics

Listen to the William Tell Overture. | Composed by Rossini | Performed by Grimethorpe Colliery Band.

Draw the dynamics:

Choose two colours. One that you think would be good for forte (loud) and one for piano (quiet).

Listen to the music. When the music is loud, draw lines using your loud colour. When it's quiet, use your quiet colour.

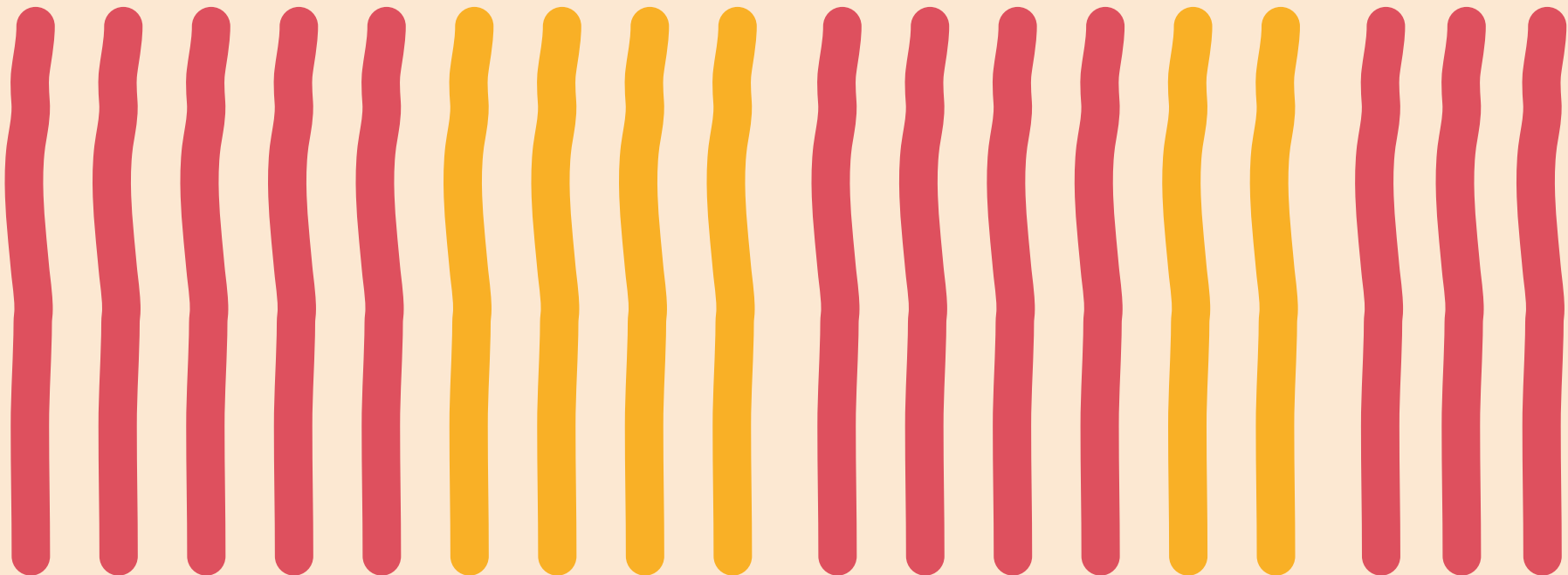

# FIND OUT MORE... dynamics

## Reading and drawing dynamics:

Often in music, composers write dynamics using letters like *f* (for forte) and *p* (for piano). Did you know you can show dynamics using pictures or symbols as well? We call this graphic notation.

Can you read and play the dynamics written here?

Use your white board to create some of your own. Ask a partner to play them.





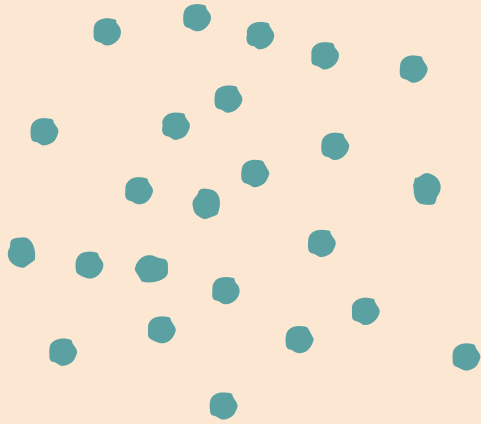

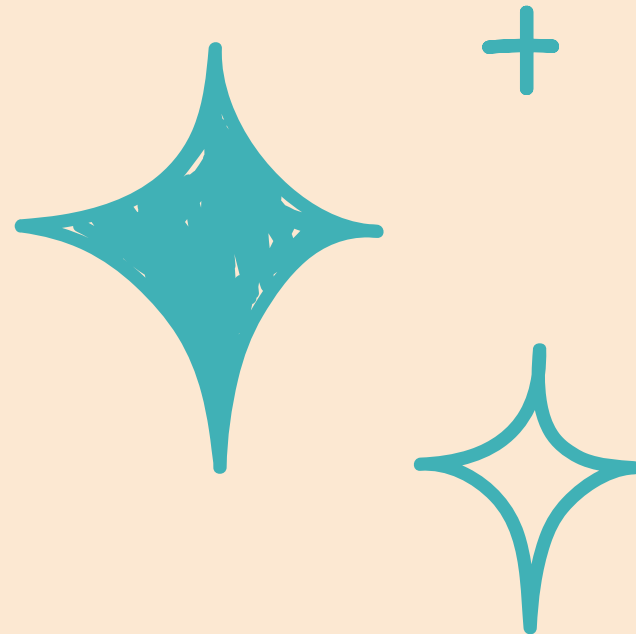
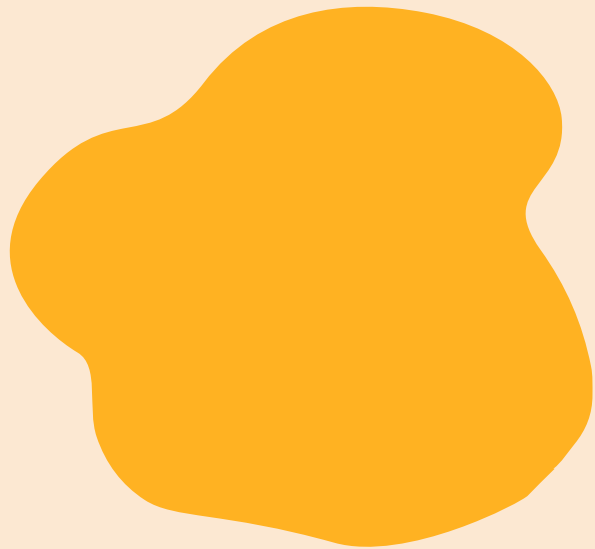

## FIND OUT MORE... making an instrument

Your school has a special day in July when it is going to be visited by a Brass Band. We think you'll love it!

It's always fun to join in with the band. Here are some instruments you could make so you can join in.



# FIND OUT MORE... making an instrument

## Paper Plate Shaker

You will need:

1 paper plate each

Rice

Stapler or glue

Something to decorate with - paint, pens, glitter, crayons



### Step 1

Fold your paper plate in half and decorate it.

You might like to colour in and stick on some of the templates below.

### Step 2

Put a small amount of rice inside your plate.  
Glue or staple the edges of your plate closed.



### Step 3

Enjoy shaking along with the band!

# FIND OUT MORE... making an instrument

## Coffee or Pringles Tin Shaker

You will need:

Coffee or Pringles tin with lid

Paper

Tape

Something to decorate with - pens, coloured pencils, glitter

Rice

### Step 1

Measure and cut paper to fit around the tin.

Decorate the paper. You might like to use some of the templates below to colour in and stick on.

Glue or tape the paper around your tin.

### Step 2

Put a small amount of rice into the tin and seal the lid shut.



### Step 3

Enjoy shaking along with the band!



# FIND OUT MORE... making an instrument

## Paper Cup Cornet

You will need:

Paper cup

Cardboard

Tape or glue

Something to decorate with - pens, coloured pencils, glitter



### Step 1

Ask an adult to cut a hole in the bottom of the paper cup for you.

Cut a piece of A4 card in half, roll it into a tube and stick it together.

Put the tube inside the hole in the cup.

### Step 2

Draw three dots onto the cardboard tube to be your cornet valves (the things that get pushed down when you play)

Decorate your cornet.

### Step 3

Enjoy tooting along with the band!



You might like to decorate these brass instruments or the Brass Foundations logo, cut them out and stick them onto your instruments.

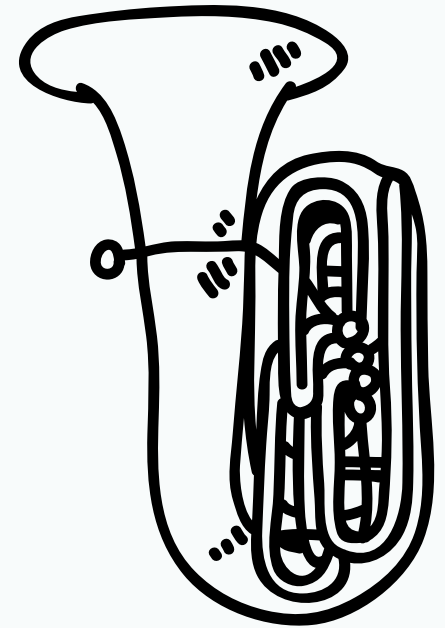
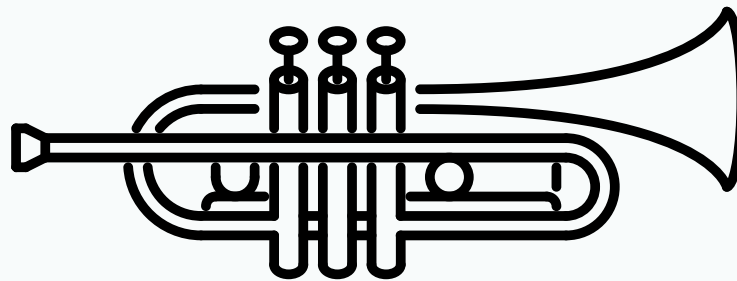
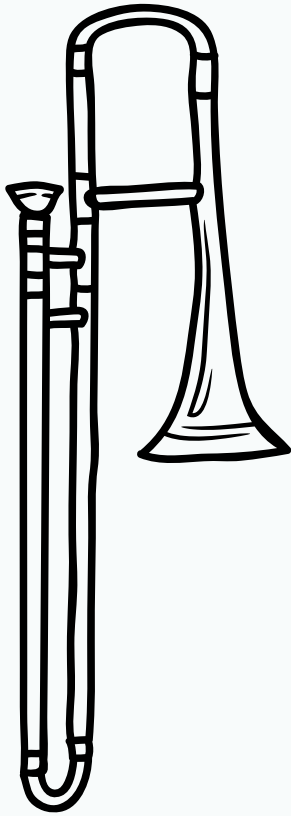

FIND OUT MORE... writing a review

Your school has a special day in July when it is going to be visited by a Brass Band. We think you'll love it!

Once you have heard the band play, we'd like you to be a reporter and tell us all about it!

Your teacher might be able to send your review to the band so they know what your favourite bits were.





# FIND OUT MORE... writing a review

Name \_\_\_\_\_ Year \_\_\_\_\_

School \_\_\_\_\_

How did the music make you feel?



My favourite part of the concert was ...

---

---

---

---

---

---

---

Circle the words that you think describe the music that the band played. Add some of your own words.

Loud      Sad      Fast      Spikey  
Jumpy      Calm      Happy  
Entertaining      Smooth      Sleepy  
Bouncy      Fun      Excited      SLOW  
Quiet

Rate the concert by colouring in the stars.

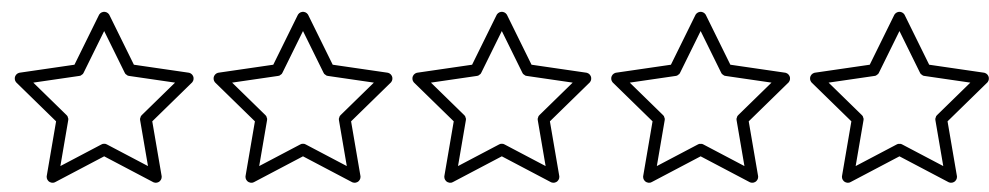

FIND OUT MORE... writing a review

Draw a selfie of you playing one of the instruments you saw in the concert.



FIND OUT MORE... learn to conduct!

Your school has a special day in July when it is going to be visited by a Brass Band. We think you'll love it!

Brass Bands play lots of different types of music with brass and percussion instruments. To make sure they all work together, each band also has a conductor.

One of our Brass Foundations team members has made some conducting videos for you to watch. After you've watched them, try some of the activities below,

Learn to conduct with Paul and the Amersham Band.

[Conducting in 2](#)

[Conducting in 3](#)

[Conducting in 4](#)

## FIND OUT MORE... learn to conduct

Watch the videos of Paul conducting the Amersham Band.  
Try following his pattern for conducting in 2, 3 or 4 beats in a bar.

### Conduct your class!

Your class could use their voices or instruments for these activities. You can choose any song they know and use it for these activities.

#### Starting and stopping

Use your hands to show your class when to start singing or playing.

Can you show them when to stop? Did they all stop together?

#### Dynamics

With your hands, make big movements when you want the music to be loud and small movements when you want it to be quiet.

#### Tempo

Speed up or slow down your conducting.

# FIND OUT MORE... Music Stand Banners

Your school has a special day in July when it is going to be visited by a Brass Band. We think you'll love it! British Brass Bands are traditional, musical ensembles that include a wide variety of brass instruments and percussion. The music that they play is really varied, from operatic overtures to pop music.

When Brass Bands play in public, in concerts and events, all the players wear a uniform and they also decorate their music stands with a 'music stand banner'. Traditionally, included on the banner is the name of the Brass Band, a logo or symbol that represents the Brass Band, and maybe some important colours to do with the Band.

Here are some examples of banners that belong to Brass Bands.



You are going to design a banner for your school Brass Band.

You might include colours that are special to your school.

You might include symbols that show what is important about your Brass Band.

You should include the Brass Band's name. Has it got a name?

Write your name on the back.

Teachers, if you are going to use the children's designs for real music stands, do measure the size of the stand as A4 may not fit.

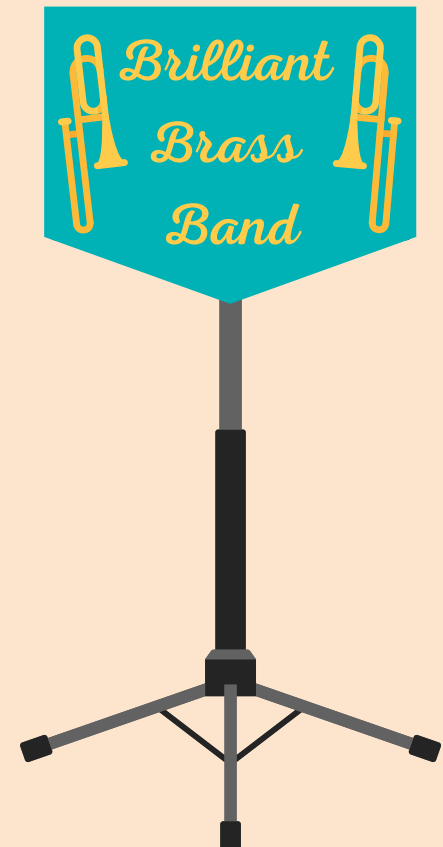

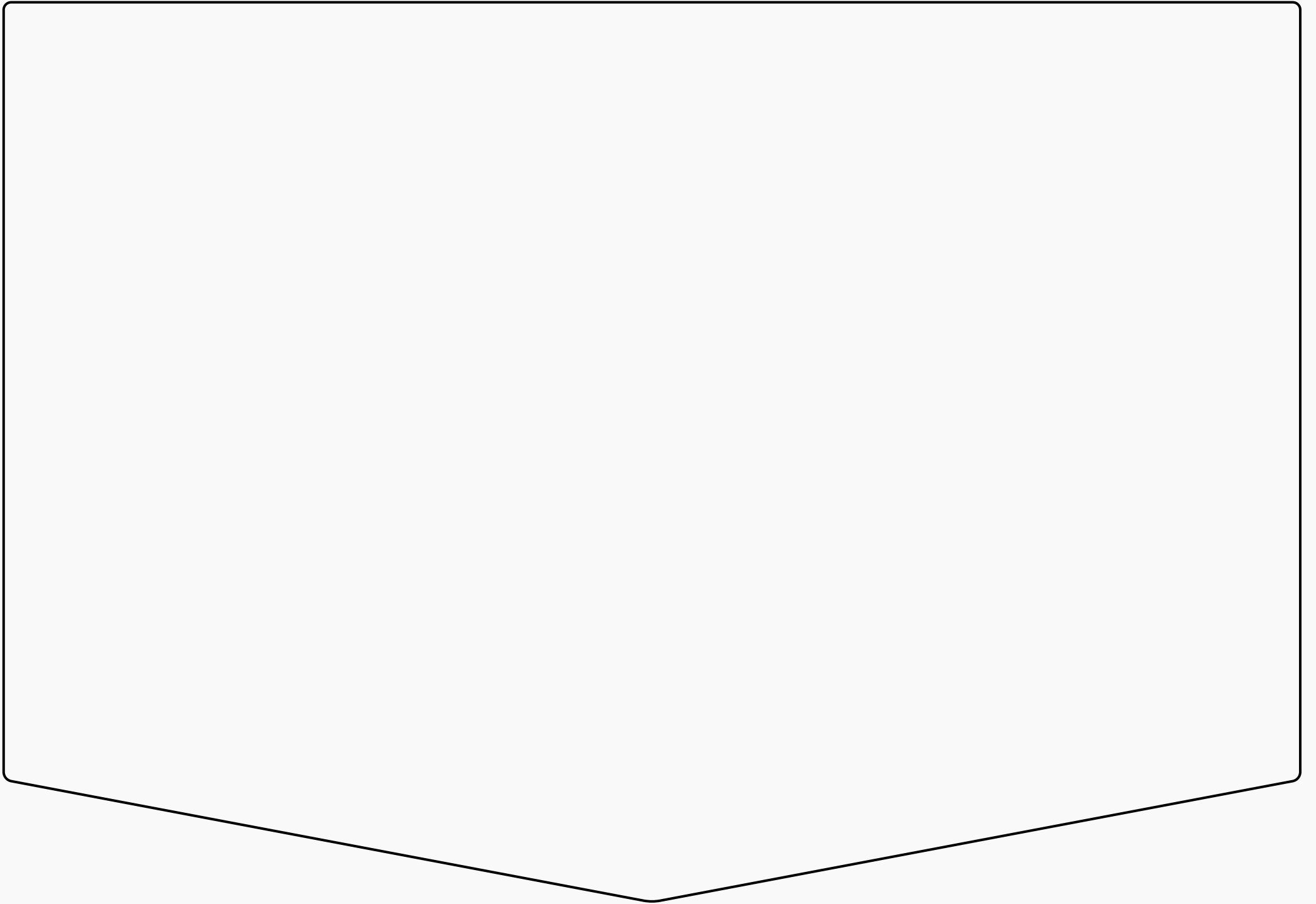

## FIND OUT MORE... Proms in the Playground Bunting



#PromsInThe  
Playground  
4-22 July 2022

Your school has a special day in July when it is going to be visited by a Brass Band. We think you'll love it! British Brass Bands are traditional, musical ensembles that include a wide variety of brass instruments and percussion. The music that they play is really varied, from operatic overtures to pop music.

When there are special events or occasions, we like to decorate our surroundings in lots of different ways. Bunting is one traditional way that you can decorate your classroom, your playground, or your school hall, to celebrate something special.

Because a Brass Band is coming to visit your school, we would love to see some bunting decorating the performance area where the Brass Band will play. You can design your own bunting, but it should be about music and Brass Bands.

We have provided some templates that you can colour in or some plain bunting for you to make your own designs. Have fun!



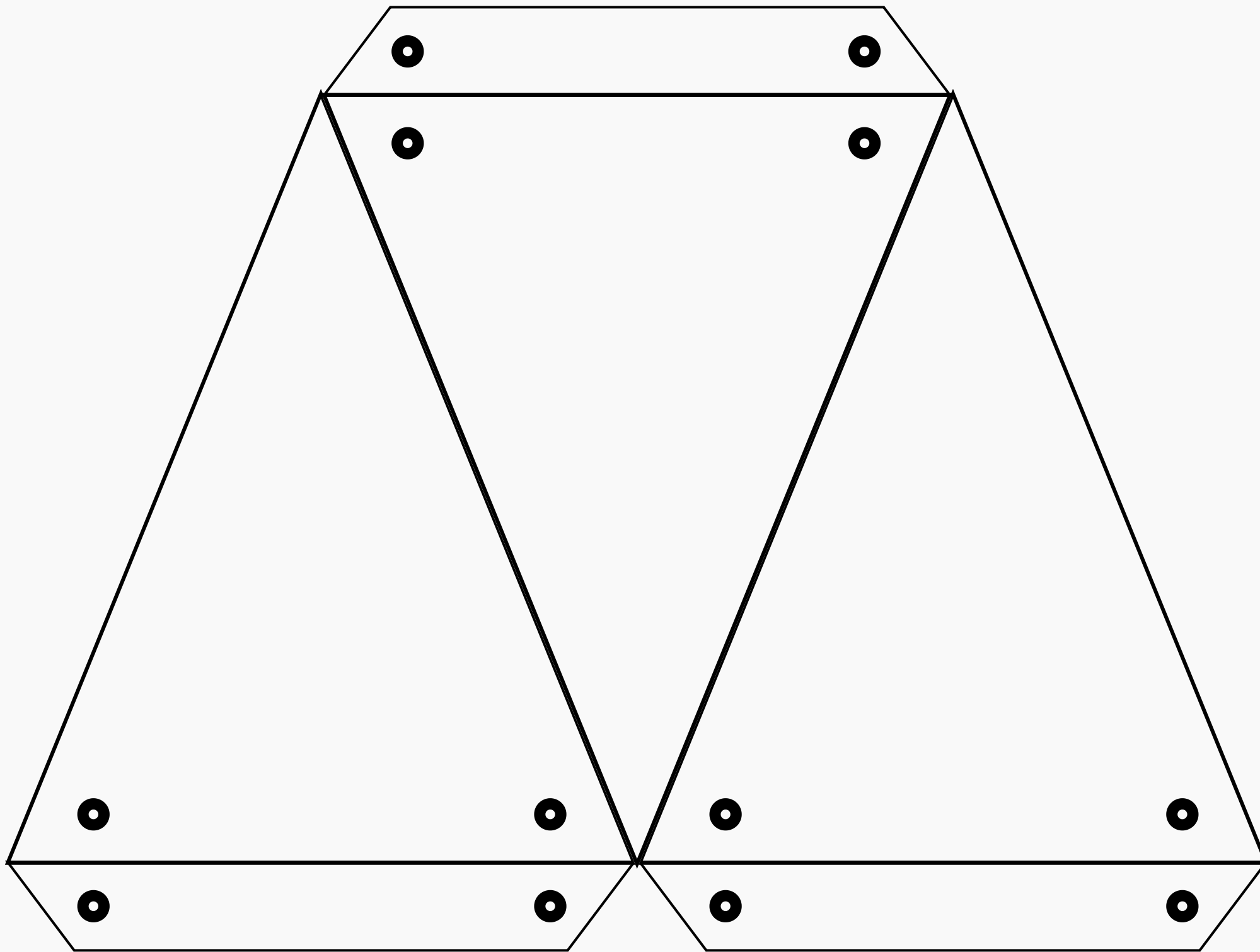



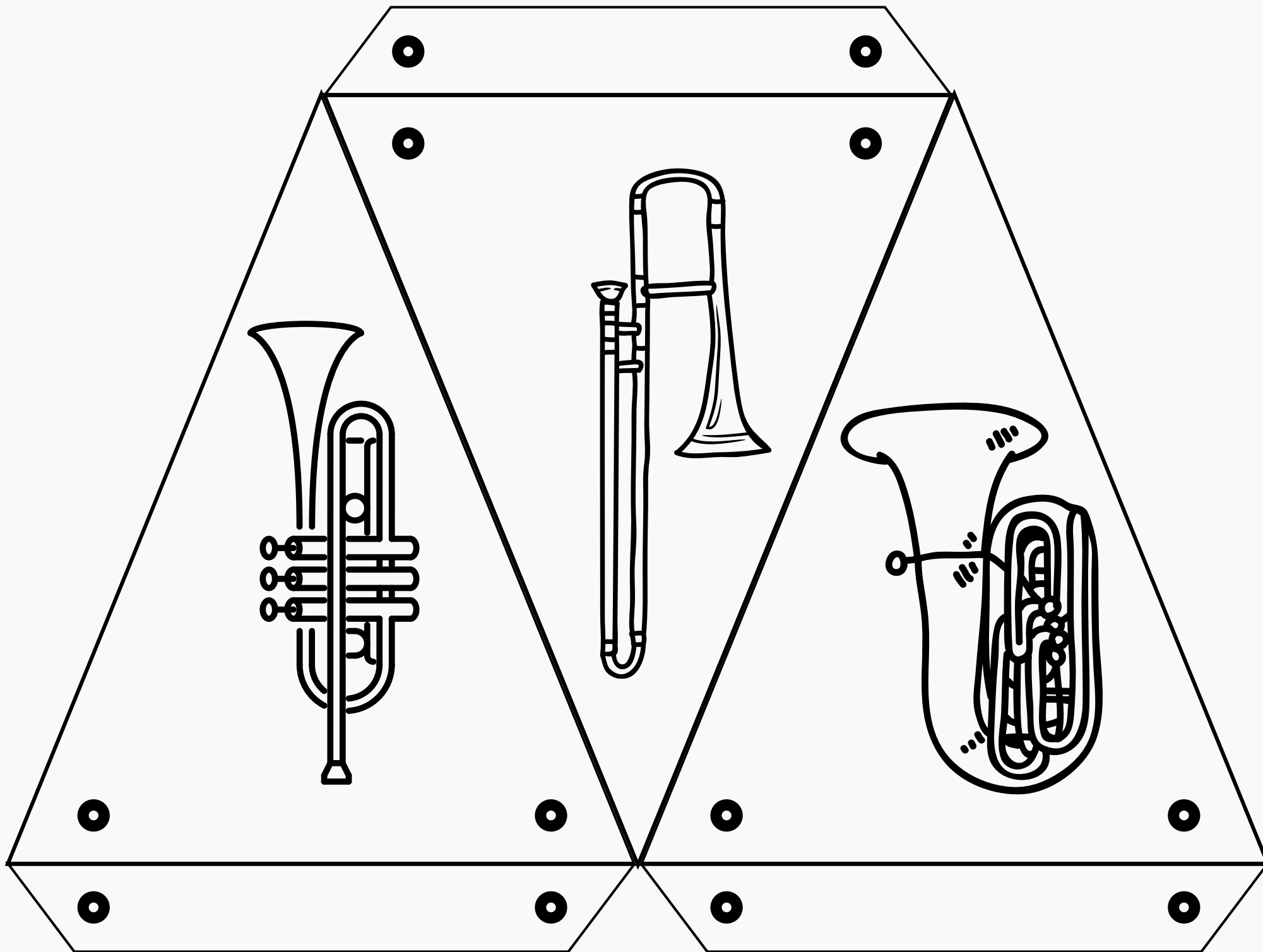

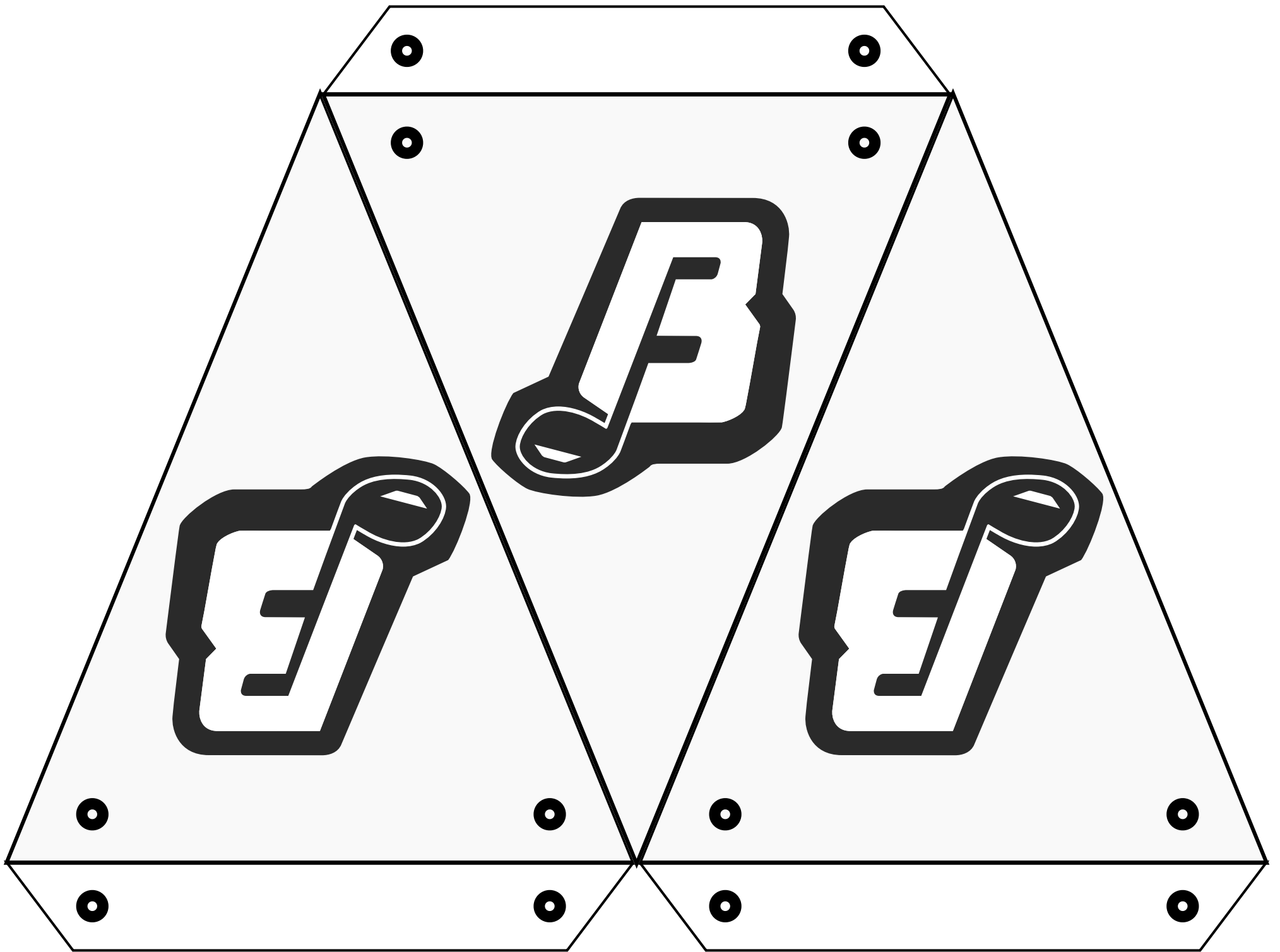

# FIND OUT MORE... composing a fanfare

Your school has a special day in July when it is going to be visited by a Brass Band. We think you'll love it! One thing that brass instruments are great at doing is playing fanfares and today, it's your turn to write and play your own.

Let's watch some fanfares being played!

Fanfare for a Dignified Occasion | Composed by Arthur Bliss | Performed by the London Fanfare Trumpets

Bugler's Dream Olympic Fanfare | Composed by John Williams | Performed by the Bands of HM Royal Marines

Fanfare from the Overture to William Tell | Composed by Giachino Rossini | Performed by the Cory Band

## Musical context

What is a fanfare?  
What occasion might you hear a fanfare being played at?  
Who might a fanfare be written for?

## Musical discussion

Does a fanfare use lots of notes or just a few?  
Do the notes step up and down or jump?  
What makes the fanfare sound like it's announcing something?

## Composing your own fanfare

Use your brass instrument or any other instrument you play to compose your own fanfare, using the steps below. You might like to play it to announce the start of your Proms in the Playground event.

You could do this by yourself, with a partner or in a group.

# FIND OUT MORE... composing a fanfare

## First

Decide which notes you will use.

Three or four notes is a good number for a fanfare.



## Next

Use your instrument to play the notes you have chosen and to work out how your fanfare will sound.

You can use each note and each idea more than once.



## Then

Make improvements to your fanfare.

Try adding dynamics (different volumes) or choreography (movement) to make it more interesting.



## Finally

Memorise your fanfare and practice it until it is ready to perform at your Proms in the Playground.

## Evaluate

Listen to all the fanfares in your class. Choose one or two to be performed at your Proms in the Playground. The whole class might be able to learn to play it together.

## Play it again...

Plan some other occasions to play your fanfares at. Perhaps you could play it at the start of your sports day or at a prize giving assembly.

## FIND OUT MORE... analyse dynamics

Your school has a special day in July when it is going to be visited by a Brass Band. We think you'll love it! British Brass Bands are traditional, musical ensembles that include a wide variety of brass instruments and percussion. The music that they play is really varied, from operatic overtures to pop music.

Your teacher is going to record the band so that you can listen back to some music played on the day. They will choose a piece of music that has interesting DYNAMICS.

What are Dynamics? \_\_\_\_\_

When music is written down in traditional notation, the volume of music is represented by abbreviations of Italian words. The most common terms in use are below:

***ff*** Fortissimo  
Very Loud

***mf*** Mezzo Forte  
Moderately loud

***p*** Piano  
Softly

***f*** Forte  
Loud

***mp*** Mezzo Piano  
Moderately soft

***pp*** Pianissimo  
Very softly

# FIND OUT MORE... analyse dynamics

You are going to create a graph that depicts the dynamics of the piece of music chosen by your teacher.

1. Add the duration of the piece of music in minutes and seconds in the box at the end of the x axis. Divide the x axis equally into separate minutes with your ruler, marking each minute with a short line along the line. The x axis is 20cm long.
2. Mark the y axis with six the divisions of dynamics, with the quietest dynamic at the bottom and the loudest dynamic at the top.
3. As you listen to the music, plot the dynamics on the graph below. You may show this as a line graph, a scatter graph or a bar graph.



## FIND OUT MORE... Interrelated dimensions of music

Your school has a special day in July when it is going to be visited by a Brass Band. We think you'll love it! British Brass Bands are traditional, musical ensembles that include a wide variety of brass instruments and percussion. The music that they play is really varied, from operatic overtures to pop music.

Listen really carefully to one of the pieces of music that the Brass Band is going to play. You are going to be asked questions about the music they play, BUT, more specifically, how the different parts of the music work with each other.

The dimensions that you are going to be asked about are these:

### **Pitch**

How high or low the notes are.

### **Timbre**

What the sounds sound like.

### **Texture**

How many instruments playing at the same time.

### **Dynamics**

How loud or soft the music is.

When single notes combine with others

### **Harmony**

### **Pulse**

The beat that runs throughout a piece of music.

### **Rhythm**

Different note lengths arranged into patterns.

### **Tempo**

How fast or slow the music is and if that changes.

The tune in a piece of music

### **Melody**

# FIND OUT MORE... Interrelated dimensions of music



#PromsInThe  
Playground

2022 July 2022

Choose a piece of music that the Brass Band is going to play. Write its title and composer in the space below.

Title of Music..... By .....

What are the most important aspects of this piece of music? Does it have a striking melody? Is the rhythm infectious? Are the dynamics dramatic? Does the harmony make you feel emotional?

You are going to put the interrelated dimensions of music in order of importance for this piece of music. Cut out the shapes and stick them on the sheet in the order of importance for you - this is your opinion - where 1 is the most important and 9 is the least important. Can you explain your decision?

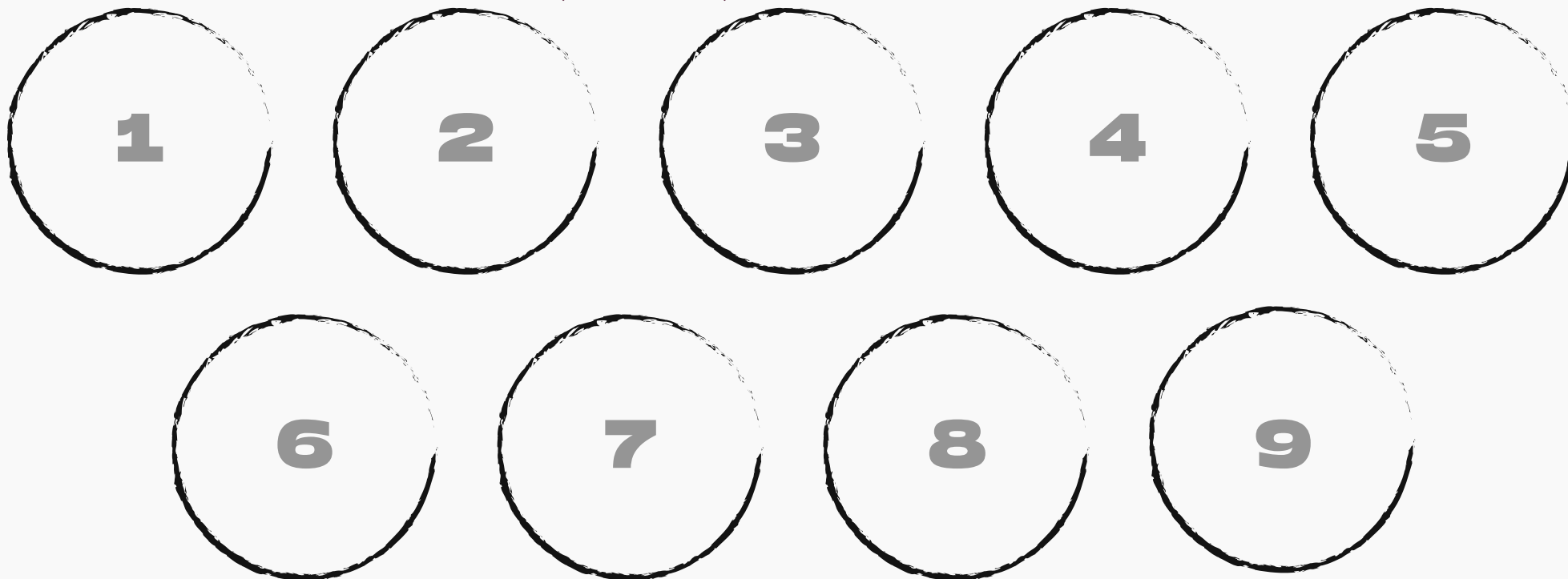

Name..... Class.....



Cut out the shapes

**Pitch**

How high or low the notes are.

**Timbre**

What the sounds sound like.

**Pitch**

How high or low the notes are.

**Timbre**

What the sounds sound like.

**Pulse**

The beat that runs throughout a piece of music.

The tune in a piece of music

**Melody**

The tune in a piece of music

**Melody**

**Texture**

How many instruments playing at the same time.

**Pulse**

The beat that runs throughout a piece of music.

**Texture**

How many instruments playing at the same time.

**Rhythm**

Different note lengths arranged into patterns.

**Rhythm**

Different note lengths arranged into patterns.

**Dynamics**

How loud or soft the music is.

**Dynamics**

How loud or soft the music is.

**Tempo**

How fast or slow the music is and if that changes.

**Tempo**

How fast or slow the music is and if that changes.

When single notes combine with others

**Harmony**

When single notes combine with others

**Harmony**



## FIND OUT MORE... focused listening activities

Your school has a special day in July when it is going to be visited by a Brass Band. We think you'll love it! British Brass Bands are traditional, musical ensembles that include a wide variety of brass instruments and percussion. The music that they play is really varied, from operatic overtures to pop music.

### CHRISTOPHER BOND

Christopher is a professional composer, conductor and musical director, who came from Cornwall but now lives in Cardiff. Since 2015, he has been 'Composer in Residence' to the Cory Band. His music has been performed all over the world and in the United Kingdom, his work has been broadcast on BBC Radio 2, 3, 4 & Classic FM.

Most of Christopher's music is written for brass bands and he is heavily involved in the activities surrounding brass bands, such as adjudicating at their performance competitions, composing competitions and the musical education of young musicians.

You can listen to the music on this link:  
<https://soundcloud.com/christopherbond/music/storyteller-brighthouse-rastrick-band>.

Do you recognise some parts of the music?  
Might you have heard some snippets of this music before?

### STORYTELLER

This music was written for a music competition where brass bands are not just judged on their ability to play the music, but also on their ability to entertain an audience. This music was played by the Brighthouse and Rastrick Band from Yorkshire in 2016.

How does this music make you feel? Write a short paragraph that tells us what it is about the music that makes you feel that way. Be sure to use lots of adjectives that describe your emotions and the effect that it has on you. Enjoy!



## STORYTELLER For Brass Band

By Christopher Bond

## FIND OUT MORE... focused listening activities

Gavin Higgins is one of the most exciting and gifted composers in Britain today. He was born in Gloucestershire (1983) and studied french horn and composition at some esteemed, British music establishments. Gavin's family can trace their musical heritage back to 1895 as working-class brass band musicians and his passion for this heritage has resulted in him writing a number of larger scale pieces of music for brass bands. Gavin also writes for orchestra and for solo instruments, and he writes music for choir and for opera. In 2022,

Gavin wrote the innovative 'Concerto Grosso for Brass Band and Orchestra' which was performed at the BBC Proms at the Royal Albert Hall. He won the Royal Philharmonic Society Award in the Large-Scale Composition category in March 2023 for this piece that was premiered at the BBC Proms in 2022 with the BBC National Orchestra of Wales, and Tredegar Town Band, conducted by Ryan Bancroft. It got great reviews.

The composer has an artistic relationship with the Tredegar Town Band. You can watch a video here about Gavin and the Band. In the video, Gavin also talks briefly about his diagnosis with Tourettes and Obsessive Compulsive Disorder and how music helped him,

<https://www.bbc.co.uk/news/uk-wales-62334839>

Gavin says of his Concerto Grosso for Brass Band and Orchestra,

"...-this music is close to my heart. Concerto Grosso for Brass Band and Orchestra is a love letter to that music and to those communities."

You can look at the 'score' of this music at this link to see what the music looks like.

[https://issuu.com/gavinhiggins/docs/50pggavin\\_higgins\\_-\\_concerto\\_grosso\\_for\\_brass\\_band](https://issuu.com/gavinhiggins/docs/50pggavin_higgins_-_concerto_grosso_for_brass_band)

## Gavin Higgins

### Some brass pieces by Gavin Higgins

Destroy, Trample as Swiftly as She (2011)

Prophecies (2017)

So Spoke Albion (2019)

Sadly Now the Throstle Sings

Toccata (2013)

Ar Lan Y Môr (2022)

"I think it's the occasion when the poor old critic has to reach for the sharpest word in their lexicon, which in my case is, 'wow! It was a spectacular piece, it was magnificent in this hall... just an astonishing jamboree of sound."

Fiona Maddocks, the Observer

Musicians of the Tredegar Town Band from Wales."



# FIND OUT MORE... focused listening activities

You are going to listen to a piece of music by Gavin Higgins called "Ivory Ghosts". This is an expressive piece of music that encourages us to feel emotion about the plight of wild elephants in Africa who are hunted for their ivory. You are going to be asked questions about how it achieves its expression by using the interrelate elements of music. Go to the music using the link below:

<https://soundcloud.com/gavin-higgins-music/ivory-ghosts>

Below is a list of instruments that are playing the music. Underline that ones that you can hear and recognise.



Soprano Cornet  
Cornet  
Flugel Horn  
Tenor Horn  
Baritone Horn  
Euphonium  
Trombone

Bass Trombone  
Tubas  
Vibraphone  
Marimba  
Cymbal  
Bass Drum  
Tubular Bells

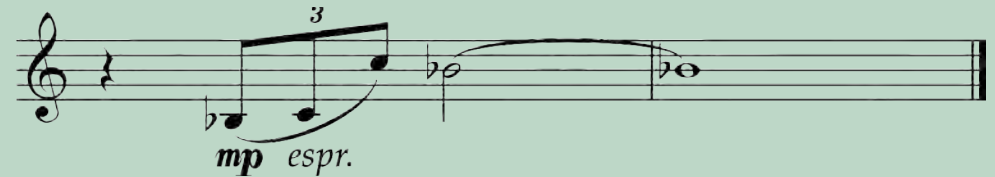

1. You'll hear the music above many times in the music. It's not always on the same notes and not always the exact shape as this, but knowing what you know about the music, what do you think it represents? \_\_\_\_\_
2. The motif above can be heard at 1: 48. What two instruments play in duet with each other for about 14 seconds? Use the list to the left to help you. \_\_\_\_\_
3. Look at the sound wave shape of the whole piece of music from Soundcloud, below, What do the vertical white lines represent? Why are some lines taller and denser than others?

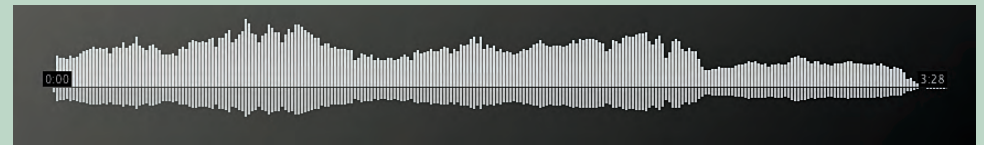

3. Using the musical terms p, mp, mf, f, ff  $\langle$  and  $\rangle$  indicate the music's dynamic journey in the white space above, following the clues from the sound wave.



<https://www.youtube.com/watch?v=D991a4-Z74I&t=17s>

## WICKED

## LUCY PANKHURST

## COMPOSER

### Lucy Pankhurst

Lucy Pankhurst is a composer from the northwest of England. She studied tenor horn and composition when she was at University. In 2020 she was also awarded a PhD for her work focussing on contemporary applications of the traditional brass band. She was the first female composer to win a "British Composer Award" (now the Ivors) in 2020. Her piece for Brass Band, "In Pitch Black" was also the first brass band piece to win an Ivor (Brass/Wind category)

### Wicked

This piece of music was composed for a brass band competition in 2014. It features the EUPHONIUM in the introduction, playing in an unusual way. Later in the music, you can hear solos from other instruments, including the cornet, tuba, trombone, and tenor horn.

Place these instruments in order of pitch (lowest first)

1 \_\_\_\_\_ 2 \_\_\_\_\_  
3 \_\_\_\_\_ 4 \_\_\_\_\_



### The Euphonium

The euphonium is a member of the brass family and is a kind of tuba. The word comes from the greek language meaning "sweet sound". They have either three or four valves and have been in use since 1874 in British brass bands, military bands and occasionally, orchestras. Some famous euphonium players include Prof David Thornton, Trevor Groom, Prof David Childs, Lyndon Baglin.

### Questions

1. How many tubas can you see being played?  
\_\_\_\_\_
2. What technique does the euphonium use in the introduction?  
\_\_\_\_\_
3. What percussion effect can you hear (and see) at 1:30  
\_\_\_\_\_
4. What instruments are being played behind the tubas? \_\_\_\_\_
5. What instrument is being played by the person sat down on the left at the front?  
\_\_\_\_\_

# FIND OUT MORE... create a graphic score

Your school has a special day in July when it is going to be visited by a Brass Band. We think you'll love it! British Brass Bands are traditional, musical ensembles that include a wide variety of brass instruments and percussion. The music that they play is really varied, from operatic overtures to pop music.

You can do this activity either before or after the Band Band plays for you.

If the band has provided you with a programme of their pieces, you can choose one of them to complete this activity. If you wait until they have been you can listen back to a recording of their playing.

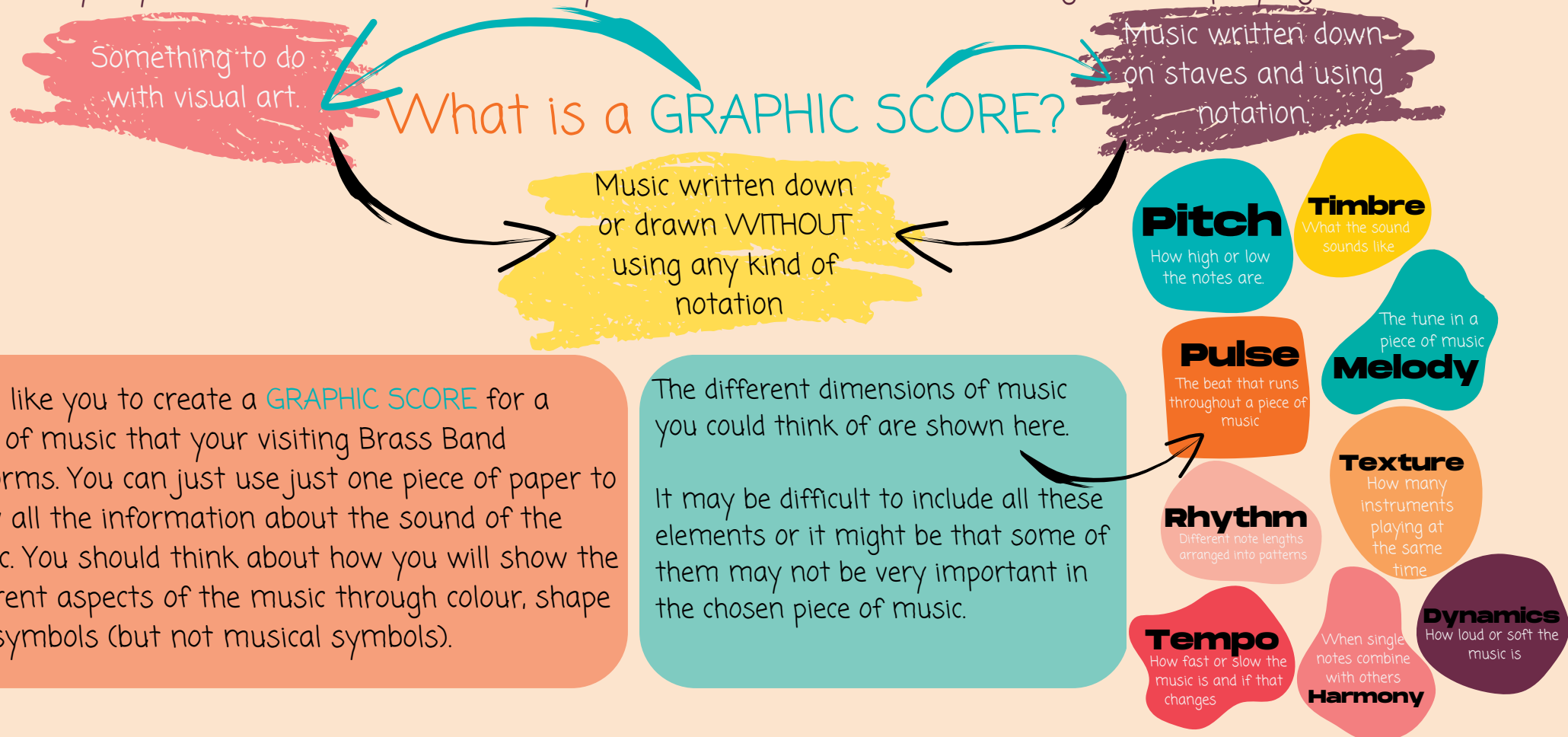

We'd like you to create a **GRAPHIC SCORE** for a piece of music that your visiting Brass Band performs. You can just use just one piece of paper to show all the information about the sound of the music. You should think about how you will show the different aspects of the music through colour, shape and symbols (but not musical symbols).

The different dimensions of music you could think of are shown here. It may be difficult to include all these elements or it might be that some of them may not be very important in the chosen piece of music.

## FIND OUT MORE... create a graphic score



#PromsInThe  
Playground

This link takes you to some examples of graphic scores that have been created or musicians to read and to 'play' the music from.

<https://www.classicfm.com/discover-music/latest/graphic-scores-art-music-pictures/>

As you have seen from the graphic scores on the link above, some graphics scores are not just a set of instructions for the musicians to play, they become a work of art in themselves.

Take care with your work and enjoy the process of creating your own images that represent the music sounds that you hear.

# FIND OUT MORE... a composer and their music



BBE BRASS  
FOUNDATIONS

#PromsInThe  
Playground

Your school has a special day in July when it is going to be visited by a Brass Band. We think you'll love it! British Brass Bands are traditional, musical ensembles that include a wide variety of brass instruments and percussion. The music that they play is really varied, from operatic overtures to pop music.

Your teacher has found out one of the pieces that they will play for you when they visit. You have been given the title and the name of the composer. The composer is the person who wrote the music, but who are they and what can you find out about them other than their name?

Using safe searching, find out as much as you can about the composer of the music under the following headings:

## Basic Info

When and where was the composer born? Are they still alive? If not, when and where did they die? How old were they when they died, or how old are they now? Does the composer play an instrument?

## Context Info

Were there any major world events that happened at the time this music was being written? Did it influence the music?

## Musical Background info

How old were they when they started writing music?

What style of music do they write?

What's their most famous piece of music?

Should we know anything about other pieces that they have written?

How famous is their music - has any of it been used for important events or films, for example?

## Music-Specific Info

What can you find out about this piece of music?

When was it written?

Is it the composer's most famous piece?

What does the music describe?

Did it originally have words - was it a song?

Do any parts of the music repeat? Can you tell if there is a specific structure?

## Instruments Info

Which instruments take the lead (the tune) in this music? Is the tune (melody) shared around the instruments?

What role does the percussion section have?

## Musical thoughts

What do you think of this music?

What does it make you think of when you hear it?

Does the music suit its title? Why do you think this?



FIND OUT MORE... a composer and their music



BBE BRASS  
FOUNDATIONS



Title of Music..... By .....

Basic Info

Musical Background info

Music-Specific Info

Instruments Info

Context Info

Musical thoughts

# FIND OUT MORE... MMC listening activities

Your school has a special day in July when it is going to be visited by a Brass Band. We think you'll love it! British Brass Bands are traditional, musical ensembles that include a wide variety of brass instruments and percussion. The music that they play is really varied, from operatic overtures to pop music.

## Music of the Spheres

### Philip Sparke

Can you name the instruments at the bottom of this page? Put the number of the instrument next to its name

This piece of music is played by a Brass Band. Brass Bands evolved from the mid 1800s in the Industrial towns and cities of Wales and mostly northern England. Today Brass Bands can be found all over the country and in other countries too, like Australia, Switzerland, the USA and Norway.

Brass Bands compete in contests and are placed in leagues, like football teams, called 'sections'. This piece of music is typical of a piece that might be played in a competition. It tests the players in all aspects of their playing, from playing tuneful melodies through to playing fast, technical passages.

The composer has taken science as the starting point for his piece of music. Pythagorus was an ancient Greek philosopher and politician and even now, his ideas have become the basis for much scientific thought

Listen to this music and draw what you think the music is trying to describe. The music lasts for about 17 minutes. Try to complete your art in this time.

Brass Bands are like little communities. They are great fun, not only because of the music that you play, but also for the friends you make and the social life that you take part in.

Philip Sparke is a living, English composer who was born in 1951. Philip is really well known for writing music for Brass and Wind Bands. You might also come across his music if you play a woodwind or brass instrument because he has written music specifically for exams.

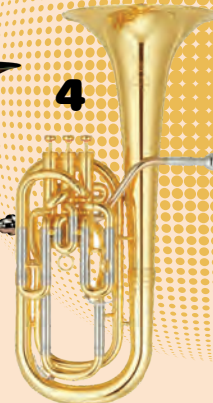

- Tuba
- Trombone
- Euphonium
- Tenor Horn
- Flugel Horn
- Cornet
- Baritone Horn



## FIND OUT MORE... MMC listening activities

Peter Graham composed this music, Shine as the Light in 2006 for a visit he made to the Salvation Army's Star Lake Music Camp. The music is played through without stopping, but there are actually three movements (or separate pieces related to each other) of music within the structure. Three Salvation Army church songs are featured throughout the music:

1. It's a Great Day
2. Candle of the Lord
3. The Light Has Come

TASK: Look at the titles of the three movements. Identify where you think each of these movements start in this performance of the International Staff Band the New York Staff Band of the Salvation Army.

<https://www.youtube.com/watch?v=ofAnDdY2LZ0>

movement 1 \_\_\_\_\_  
movement 2 \_\_\_\_\_  
movement 3 \_\_\_\_\_

## SHINE AS THE LIGHT

### Peter Graham

Peter Graham (born 1958) is a British composer for brass band. He was born in Lanarkshire, Scotland and he studied at the University of Edinburgh. He then went onto postgraduate studies at Goldsmiths College, University of London where he achieved his PhD in composition. Peter has a background that is firmly rooted in the Salvation Army and from 1983 until 1986, he lived in New York City, where he worked as a freelance composer/arranger and as a publications editor with the Salvation Army Music Bureau. Since his return to the U.K., he works as an arranger for BBC Television and Radio and has specialised in composition for brass band.



### The Salvation Army

A Salvation Army brass band is a brass band that is linked to a Corps, Division or Territory of the Salvation Army. Most of us will recognise and appreciate Salvation Army bands playing in public places during Christian events in the calendar such as Christmas in the UK. This phenomenon has become a part of seasonal customs though Salvation Army bands exist to spread the Christian message.

The commitment to playing a brass instrument in a band is just part of the picture of being in the Salvation Army. Most band members have other roles too. Salvation Army brass bands are also an excellent means of drawing attention for fund-raising and publicity.

By taking part in public events, they raise awareness of The Salvation Army and the charitable work that they do in the communities where they are based. The brass bands also provide a source of fellowship (religious companionship) for the players. This fellowship is sometimes thought to be the most important part of being in the band.

# FIND OUT MORE... musical structures

Your school has a special day in July when it is going to be visited by a Brass Band. We think you'll love it! British Brass Bands are traditional, musical ensembles that include a wide variety of brass instruments and percussion. The music that they play is really varied, from operatic overtures to pop music.

This activity is about recognising that all the music we play has a structure. Music from different traditions or genres has 'typical' structures- models that are used over and over, but all music has one.

It helps to think about a piece of music as a building (a structure). Each kind of building has a typical design. A house, for example, has exterior walls, communal living spaces, a kitchen, some bedrooms, a bathroom or two. It might also have a garage and a garden. We are used to this standard design and would expect to find these things if visiting a typical home. And so it is with lots of kinds of music. For example, it would be unusual for a pop song not to have a chorus. It would be unusual for a solo piece not to have a main theme.

Different parts of a piece of music are often described using letters of the alphabet, A, B, C etc. Here we use colours. Here are some examples of music structures:



Rondo



Ternary

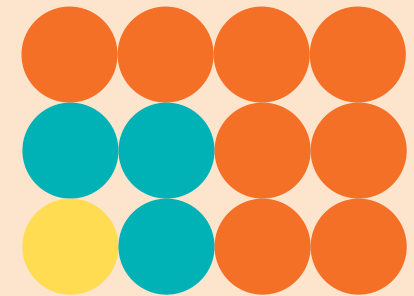

Twelve-bar blues



Binary

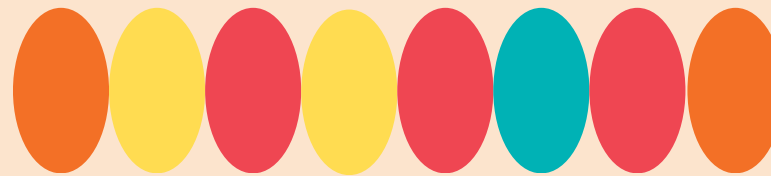

Popular song structure



Variation

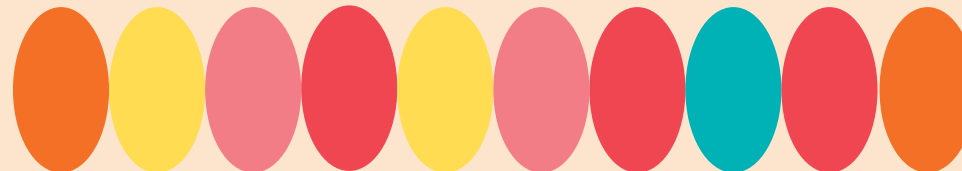

# FIND OUT MORE... musical structures

Listen to the music that your visiting band performs when they visit and choose two or three pieces to discover their structure.

- Listen out for musical ideas that repeat or keep coming back. Repetition helps the listener remember the music once it has stopped.
- Listen out for new musical ideas and how they might contrast with the first one. Contrast keeps the listener interested.

Music Title	Structure - stick the coloured shapes along the row according to the structure of the music.	
<hr/> <hr/>		
<hr/> <hr/>		
<hr/> <hr/>		

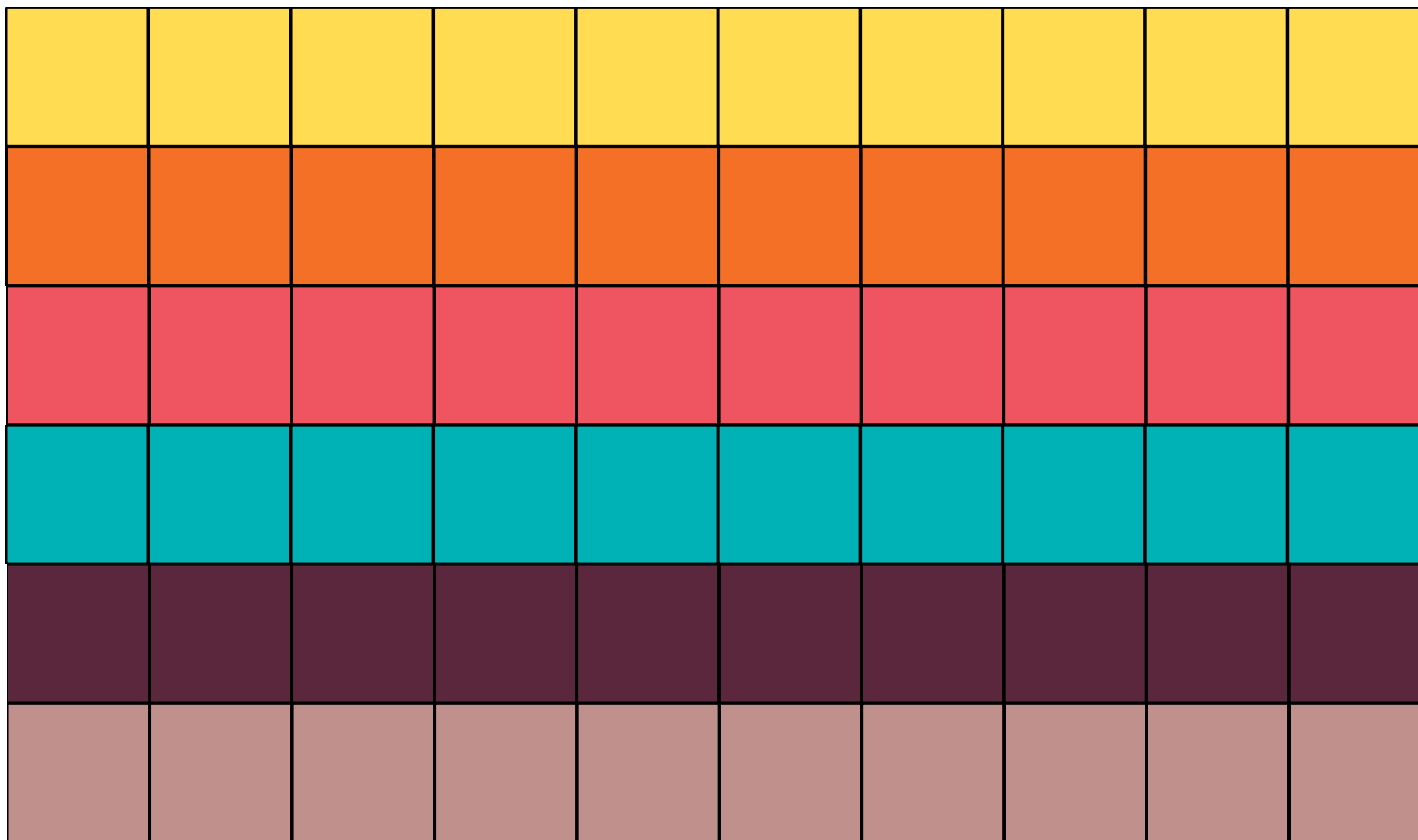

Cut out the shapes. Each square is a musical idea. Each colour is a different musical idea, Stick the squares in order in the table to represent the structure of the music you hear.

## FIND OUT MORE... Melody writing

Your school has a special day in July when it is going to be visited by a Brass Band. We think you'll love it! British Brass Bands are traditional, musical ensembles that include a wide variety of brass instruments and percussion. The music that they play is really varied, from operatic overtures to pop music.

You have been provided with the musical notes of one of tunes that the Brass Band is going to play when they visit. Here it is

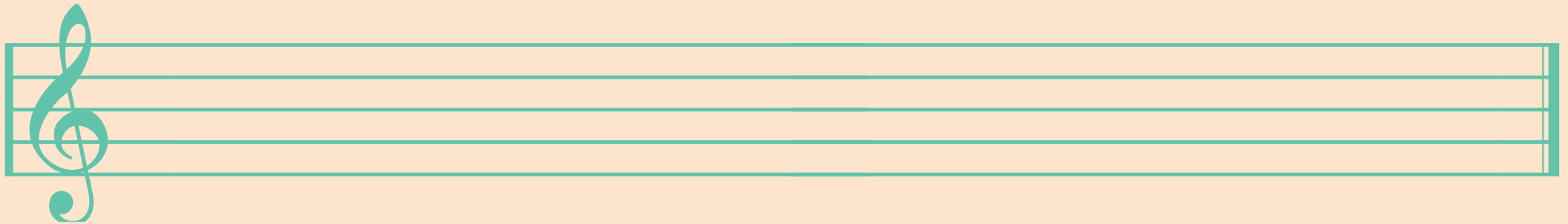

- Can you play this simple melody on your classroom instruments?
- What do you need to know to be able to perform this music? Can information be added to help you?

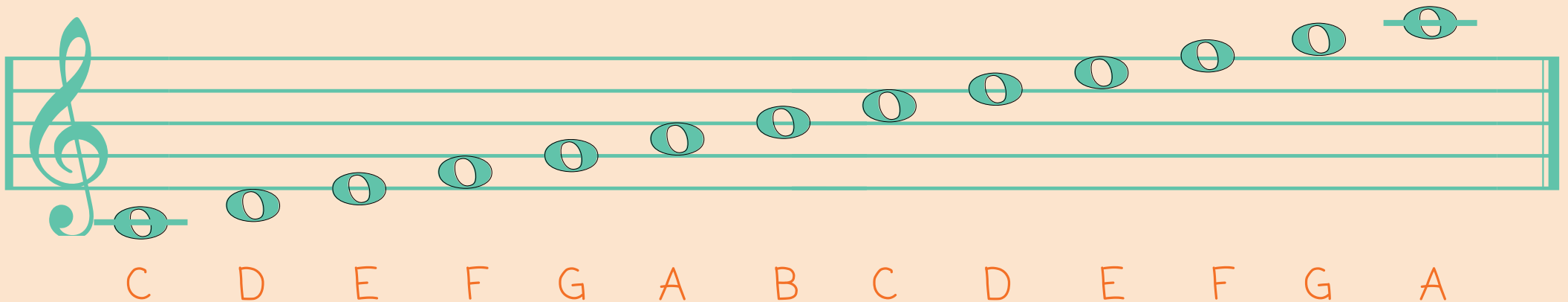

# FIND OUT MORE... Melody writing







Using the notes of the melody you have been given, can you mix the notes up into a new order to create a new and unique melody of your own?

You can repeat notes if you wish, or even miss one or two out.

Try out the your new melody on instruments in your classroom.

Write your new melody on the staff below. You can copy note lengths from the symbols below.



	Semibreve	Dotted Minim	Minim	Crotchet	Quavers	Semiquavers
Musical Durations						
	4 beats	3 beats	2 beats	1 beat	$\frac{1}{2} + \frac{1}{2}$ beat	$\frac{1}{4} + \frac{1}{4} + \frac{1}{4} + \frac{1}{4}$ beat

Name..... Class.....



## FIND OUT MORE... writing a review

Your school has a special day in July when it is going to be visited by a Brass Band. We think you'll love it! British Brass Bands are traditional, musical ensembles that include a wide variety of brass instruments and percussion. The music that they play is really varied, from operatic overtures to pop music.

The band may play a variety of music to entertain you, but we can also learn a lot from the music that you hear.

This activity is about responding to the music by writing a review. There are lots of different jobs in 'the arts'. You don't have to grow up to be a professional musician if you learn to play an instrument. You don't have to become a professional artist if you are good at painting or drawing. There are lots of jobs that support the arts sector that are really interesting and one of those is to write reviews of arts experiences - going to a concert, listening to an album, visiting an art gallery or even interviewing a performer or composer. This job is called a 'critic'.

Your task is to write a review of the performance of the Brass Band that has visited your school. The review can be shared on your school website, in your school newsletter, or even on social media. It would be good to share it with the band so that they have an idea of how well received they were when they visited you. The Brass Foundations team would also love to read your reviews and they can be sent to the team at the following email addresses:

Sheila Allen - [sheila@bbe.org.uk](mailto:sheila@bbe.org.uk) - Warwickshire

Paul Fisher - [paul.fisher@bbe.org.uk](mailto:paul.fisher@bbe.org.uk) - Hertfordshire

Paul McLaughlin - [paul.mclaughlin@bbe.org.uk](mailto:paul.mclaughlin@bbe.org.uk) - Gloucestershire

Helen Minshall - [helen@bbe.org.uk](mailto:helen@bbe.org.uk) - Manchester

Deirdre Waller-Box - [deirdre@bbe.org.uk](mailto:deirdre@bbe.org.uk) - London / Hertfordshire



# FIND OUT MORE... writing a review

## What should you include?

1. An introduction explaining the situation.  
Why is the band there - what's the occasion?
2. Always write in the first person - Use 'I'.
3. Start with the positive things about what you have experienced. Mention the negative aspects, but unless they are really terrible, try not to make too much of a big deal about them.
4. Be as descriptive as you can, using a wide variety of vocabulary and sentence construction. This will make it more interesting to read.
5. Did other people around you seem to be enjoying experience too. How do you know? What evidence was there of this?
6. Write a new paragraph for each piece of music (if there is enough to write about for each piece of music. If there isn't, group paragraphs according to content.
7. Weigh up the experience and summarise it. Try not to be too biased either way unless the evidence presented is overwhelmingly one way or the other. How many marks out of ten would you give it?
8. Would you recommend this experience to other schools? Might it be fun to be part of a Brass Band?

What kind of words can you use describe what you have heard and seen ?

The following musical vocabulary may help you get started

*Volume / Dynamics*  
**Conductor**

**Ensemble**

*Harmony*

**Melody**

*Rhythms*

**Tempo**

**Drum Kit**

**Cornets**

**Basses**

**Trombones**

**Tenor Horns**

**Euphoniums and**

**Baritones**

**Compère**

*Uniforms*

*Banners*



### What is Proms in the Playground?

Proms in the Playground is a national, musical initiative from Brass Bands England's Brass Foundations Programme that seeks to link Brass Bands with their local school to provide a free, fun performance in their playground during the last three weeks of the summer term.

### Why should my band get involved in Proms in the Playground?

The initiative is a mutually beneficial opportunity to share in the experience of live music.

For schools, it offers a free, 'on-the-doorstep' solution to the DfE guidance that "Primary music leads should think about opportunities to invite performances from local secondary pupils or local ensembles (Hub ensembles or broader community groups), to help build links and provide role models for younger pupils." (National Plan for Music Education 2, p. 33).

For your band, it provides an opportunity to enthuse children, young people and their parents about brass bands. If you have a youth section in your organisation, it provides a potential opportunity to inspire the children (and their families) to learn to play within your band.

### What other benefits are there?

- Your band gets to take part in a national initiative
- It will benefit from the #PromsInThePlayground promotion from Brass Bands England
- You will make new connections for your band
- You can gain free advice and support from the BBE Brass Foundations Team
- You get to support the players of the future

...and be a part of an enthusiastic community of musicians and educators across the country!

## How do I get in touch with my local school?

- Use your connections - who in your band has children or grandchildren at the school? Ask them to talk to their teacher directly to make the offer.
- Find out who the music lead is in your school and phone the school directly to ask to speak to them. It's very unlikely this will be an instant connection, but a phone call is a personal touch.
- Email the music lead in the school. Often, you can find the information on the school website. We have created a sample email which you can use to make that initial introduction from your band.
- Visit the school during school hours and leave your details with the admin team.

## How do we know how to fit in with what the school are doing?

- Be sure of what you can offer before you make that initial contact. How many players might you have? How long do you think you'll play for?
- Do your research. The school's website will give you lots of information, from a calendar of events through to the music curriculum delivered at the school. Could you play music that fits into one of the music topics, or a wider curricular topic? Do you have music that is included on the Model Music Curriculum Listening lists?

## What music should we be offering to play and for how long?

- As a general rule - it's a good idea to play lots of music that the children might know. Film music, Disney music, and pop songs are great starters, but equally, don't underestimate the fun of a march or a lively piece of classical music. The Model Music Curriculum has lists of music which the DfE advise different year groups to listen to. BBE has a list of music from the listening lists that have brass band arrangements, These can be found here: [bbe.band/rep-lists](http://bbe.band/rep-lists)
- Have a look at the school's website. It will give you lots of information, from a calendar of events through to the music curriculum delivered at the school. Could you play music that fits into one of the music topics, or a wider curricular topic?

## What else can we offer the school?

- This year we have a [pack of resources](#) which you will be able to share with the school ([bbe.band/PITP-resources](#)) They have been created by qualified music teachers with a wealth of experience and are aimed at Key Stage 1 and Key Stage 2. The pack includes activities which can be used as standalone activities or can be integrated into a longer unit of work and are focused on the three basic areas of the music curriculum; performing, composing and listening & appraising. Sharing these resources with the school will give your presence a little more relevance and credibility as you will be seen as something integral to the curricular offer, not just a nice experience for the children.
- Encourage the teachers to record your visit. Many of the resources rely on a recording of at least one piece of music as a starting point for the activities which they will listen back to in class afterwards.